

Belt drive



Function:

This unit consists of a rectangular aluminium profile with 2 integrated roller guides. The carriage is moved by a belt drive. Each standard pulley has got one coupling claw on one side. Belt tension can be readjusted by a simple screw adjustment device in the carriage. This device can also be used for symmetrical adjustment of two or more linear units running parallel. The openings of the guide body are sealed with 3 stainless steel cover bands to protect the guide from splash water and dust. Alternatively, the opening can also be covered with a bellow or can be delivered without cover bands.

Fitting position: As required. Max. length 6.000 mm without joints.

Carriage mounting: By Tslots.

Unit mounting: By Tslots and mounting sets. The linear axis can be combined with any T-slot profile.

Belt type: HTD with steel reinforcement, no backlash when changing direction, repeatability ± 0,1 mm.

Carriage support: In the standard version, the carriage runs on 8 rollers which can be adjusted and serviced at a central servicing position. For longer carriages the number of rollers can be increased.

8.1

Forces and torques	Size	120		160		200	
	Forces/Torques	static	dynamic	static	dynamic	static	dynamic
F_x (N)		894	800	1900	1800	4000	3800
F_y (N)		1100	900	3000	2000	4400	3100
F_z (N)		1250	1000	3500	2800	4900	4400
M_x (Nm)		150	125	400	320	600	510
M_y (Nm)		140	120	360	300	560	480
M_z (Nm)		100	90	180	150	310	275

All forces and torques related to the following:

existing values $\frac{F_y}{F_{y_{dyn}}} + \frac{F_z}{F_{z_{dyn}}} + \frac{M_x}{M_{x_{dyn}}} + \frac{M_y}{M_{y_{dyn}}} + \frac{M_z}{M_{z_{dyn}}} \leq 1$

table values $\frac{F_y}{F_{y_{dyn}}} + \frac{F_z}{F_{z_{dyn}}} + \frac{M_x}{M_{x_{dyn}}} + \frac{M_y}{M_{y_{dyn}}} + \frac{M_z}{M_{z_{dyn}}} \leq 1$

No-load torque

Nm without cover bands	120	160	200
	1,2	1,5	1,8
Nm with cover bands	1,6	2,1	4

Speed

(m/s) max	120	160	200
	4	6	8

Tensile force

permanent (N)	120	160	200
	900	1900	4000
0,2 s (N)	1000	2090	4300

Geometrical moments of inertia of aluminium profile

I_x mm ⁴	120	160	200
	6,6x10 ⁵	22,2x10 ⁵	63,8x10 ⁵
I_y mm ⁴	38,6x10 ⁵	122,0x10 ⁵	335x10 ⁵
Elastic modulus N/mm ²	70000	70000	70000

For life-time calculation of rollers use our homepage.

Driving torque:

$$M_o = \frac{F \cdot P \cdot S_i}{2000 \cdot \pi} + M_n$$

$$P_o = \frac{M_o \cdot n}{9550}$$

- F = force (N)
- P = pulley action perimeter (mm)
- S_i = safety factor 1,2 ... 2
- M_n = no-load torque (Nm)
- n = rpm pulley (min⁻¹)
- M_o = driving torque (Nm)
- P_o = motor power (KW)

Deflection:

$$f = \frac{F \cdot L^3}{E \cdot I \cdot 192}$$

- f = deflection (mm)
- F = load (N)
- L = free length (mm)
- E = elastic modulus 70000 (N/mm²)
- I = second moment of area (mm⁴)

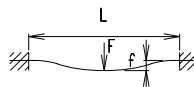

Positioning system DLZ 120, 160, 200

Dimensions (mm)

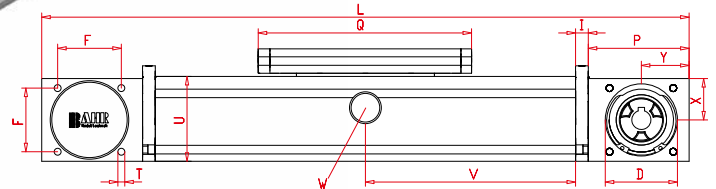
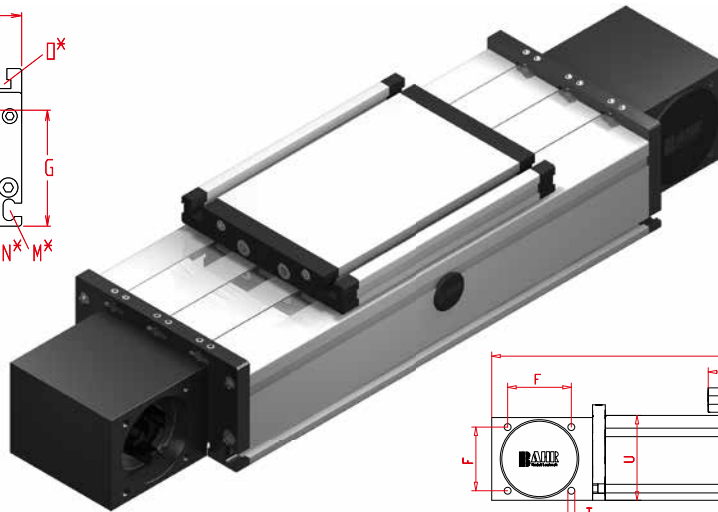
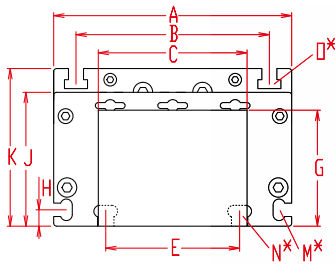

V = Q + 100 mm
W = servicing position

*For slide nuts refer to chapter 2.2 page 2

Increasing the carriage length will increase the basic length by the same amount.

Size	Basic length L	A	B	C	D -0,05	E	F	G	H	I	J	K	M for	N for	O for	P	Q	T	U	X	Y	Basic weight	Weight per 100 mm
DLZ 120	330	120	96	80	47	78	42	58	10	10	68	79	M 5	M 6	M 6	70	156	M 6	60	28	35	5,1 Kg	0,85 Kg
DLZ 160	440	160	130	100	68	90	60	78	11	12	90	106	M 6	M 8	M 8	95	200	M 8	80	39	45	13,0 kg	1,69 kg
DLZ 200	530	200	160	130	90	140	80	97	15	15	110	129	M 8	M10	M10	110	270	M10	100	49	50	23,4 kg	2,33 kg

0 Choice of guide body profile:

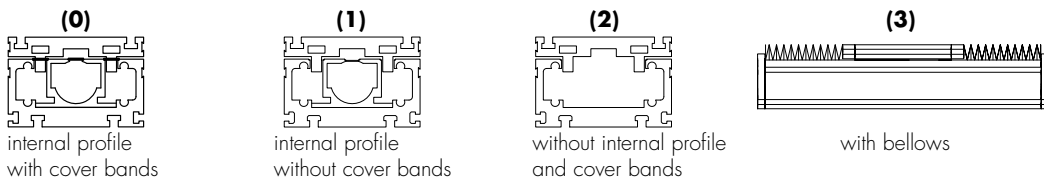

Stainless versions upon request.

0 Choice of carriage:

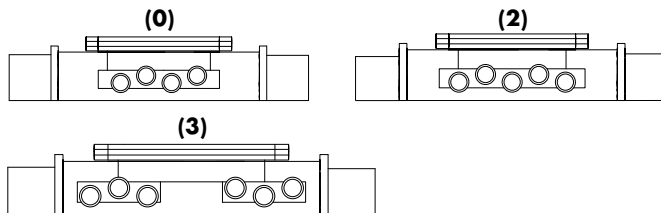

Size	Version 0		Version 2		Version 3	
	Q	L	Q	L	Q	L
120	156	330	196	370	>236	>410
160	200	440	250	490	>300	>540
200	270	530	330	600	>410	>680

0 Drive version:

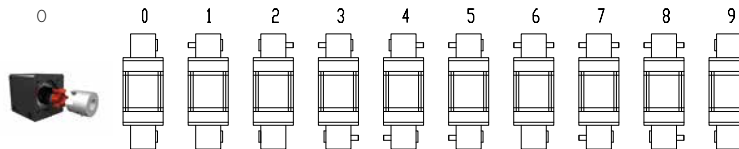

9 is as 0, but with coupling claws on both sides.
The standard version is supplied without shaft. A shaft can be retrofitted by inserting it into the pulley bore and securing it with 2 locking rings or tension sets (size 200).

Belt table

Code No.	Size	Belt	mm/rev.	Number of teeth
0 4	120	5M25	130	26
0 7	160	8M30	176	22
0 9	160	8M50	176	22
0 9	200	8M50	224	28
1 0	200	8M70	224	28

Shaft dimensions / Coupling claw

Size	Shaft ø h6 x length	Key	Coupling
120 (5M25)	14 x 35	5x5x28	14
160 (8M30)	18 x 45	6x6x40	19
160 (8M50)	25 x 35	8x7x32	— *
200 (8M50)	22 x 45	6x6x40	24
200 (8M70)	30 x 55	8x7x50	— *

DLZ 160 1 0 0 0 0 7 1 01500 — Basic length + stroke = total length

Pos. 1 2 3 4 5 6 7

Sample ordering code:

DLZ160 with internal profile and cover bands, standard carriage, coupling claw on one side, 1060 mm stroke.