



The Expert in Lubrication Solutions



## Basic Guidelines

3



## Mounting types

4-6

- Direct mounting
- Remote mounting with tube
- Mounting of oil filled units



## Preparation of lubrication point

7

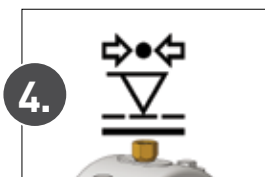

## Pressure testing

9

- Pressure test procedure



## Activation und installation

11



## Identification of lubrication system

11

© 2016 perma-tec GmbH & Co. KG

The content of this document has been compiled by perma-tec with meticulous care. Never-the-less, we cannot rule out deviations and reserve the right to make technical changes to the product without any advance notice. We do not assume any judicial responsibility or liability for any damages which may ensue as a result. Necessary modifications will be included in subsequent editions.

Compiled and printed: 03/2016

This Installation guide provides instructions for the installation of perma FLEX and helps in preventing basic mounting errors. The guide should be used with the operating instructions.

Drawings are only examples. There are many other possibilities for mounting, depending on local conditions.

Disclaimers of corresponding operating instructions apply.

Installation guides do not affect validation of the operating instructions.

## 1. Basic Guidelines

- perma FLEX is a single-point lubrication system. You must use a separate lubrication system for each lubrication point.
- The connection thread of perma FLEX is BSP R $\frac{1}{4}$  male thread.
- Replace the application's grease fitting with a suitable reducer. perma-tec offers a wide assortment of reducers, extensions, tubes, brackets and other accessories. See our product catalogue for the entire overview on perma accessories.
- Ensure that the lube point is prefilled with fresh lubricant before installation. perma-tec offers all of its lubricants in 400 g cartridges for grease guns.
- Select the right lubricant for your application. perma-tec offers a wide variety of standard lubricants for different applications. See our product catalogue for further information.
- Use medium strength threadlocker for all metal to metal connections (extensions, reducers etc.).
- Fill grease lines and accessories with the same lubricant that is contained in the lubrication system.
- perma FLEX can be used for saltwater applications (underwater usage is possible for a limited time). Protection class IP 68.
- For managing several lube points we recommend the use of a lubrication maintenance plan. You can use the free perma MLP software (<https://mlp.perma-tec.com>) for online administration.
- Please check our product catalogue for more information on how to select suitable lubricant. You may also download our free perma SELECT APP which is a great tool for the selection of the right lubrication system, lubricant and discharge period.

## 2. Mounting types

### 2.1 Direct mounting

Direct mounting should be preferred for all lubrication points, to protect the lubrication system against high pressure.



Installation of perma FLEX is possible in all directions.



## 2.2 Remote mounting with tube

Remote mounting is recommended if,

- the ambient temperature of the lubrication point is permanently higher than +60 °C
- the lubrication point is exposed to high vibrations
- no direct access to lubrication point is possible due to safety issues (e. g. removal of protective screens, safety walls or cages)
- it is difficult or dangerous to access the lubrication point
- the lubrication system is exposed to mechanical forces (e. g. falling rocks)

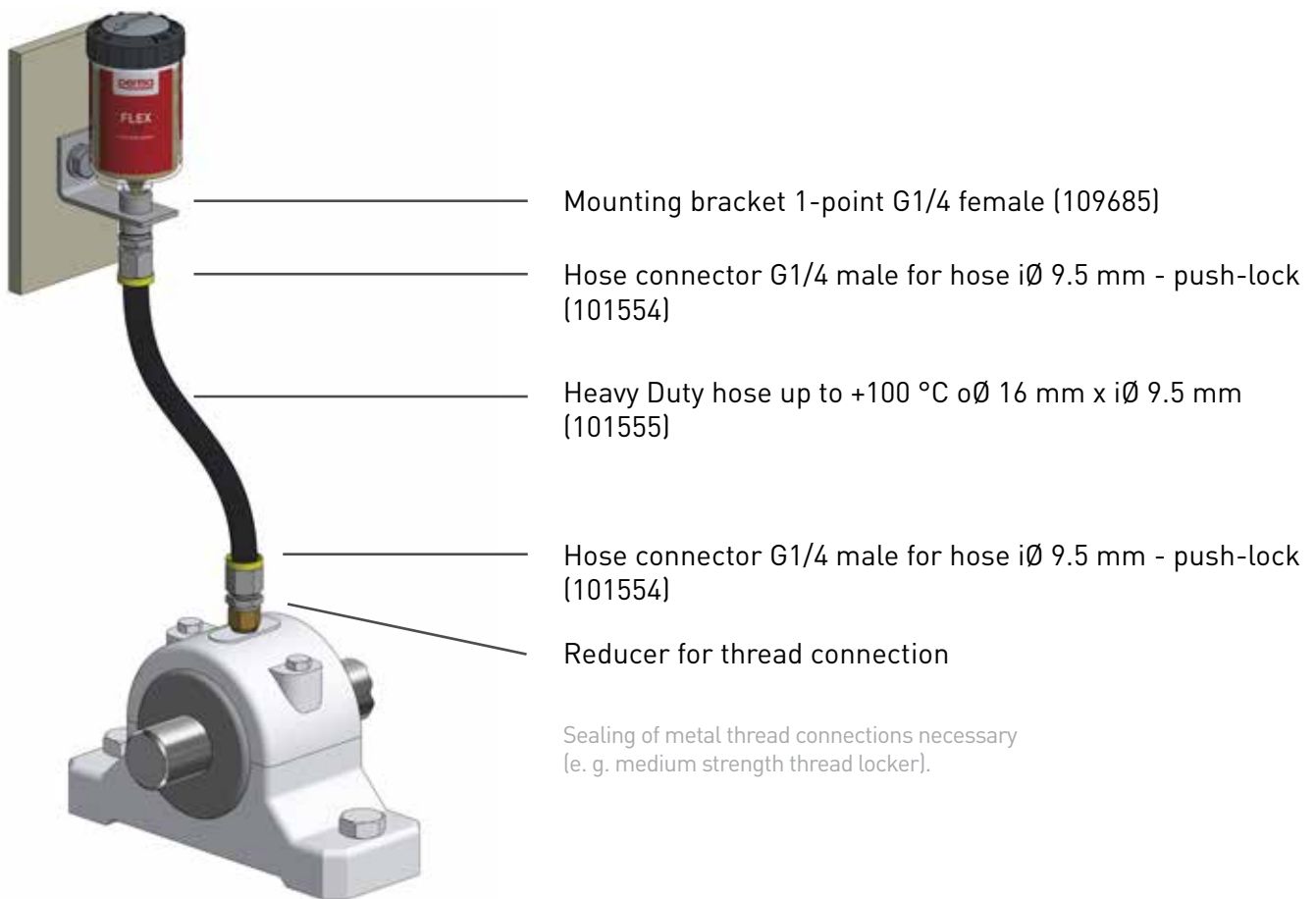

- Keep connection lines as short as possible and use tubes with an inside diameter of at least 6 mm. Keep in mind that tube length and bore diameter of bearing housings affect pressure and discharge period of the lubrication system.
- For installation of perma FLEX use Mounting bracket 1-point G1/4 female (109685).
- Secure tubes with suitable fastenings (brackets, cable ties) to protect against damage and tearing.
- Depending on lubricant and ambient temperature, different tube lengths are possible, e. g.
  - perma Multipurpose grease SF01: 1 m (+20 °C)
  - perma Multipurpose oil S032: 3 m (+20 °C).

## 2.3 Mounting of oil filled units

### 2.3.1 Direct mounting

All oil filled perma FLEX come with an integrated oil retaining valve. They can be installed directly on a lubrication brush without the need for an additional oil valve.

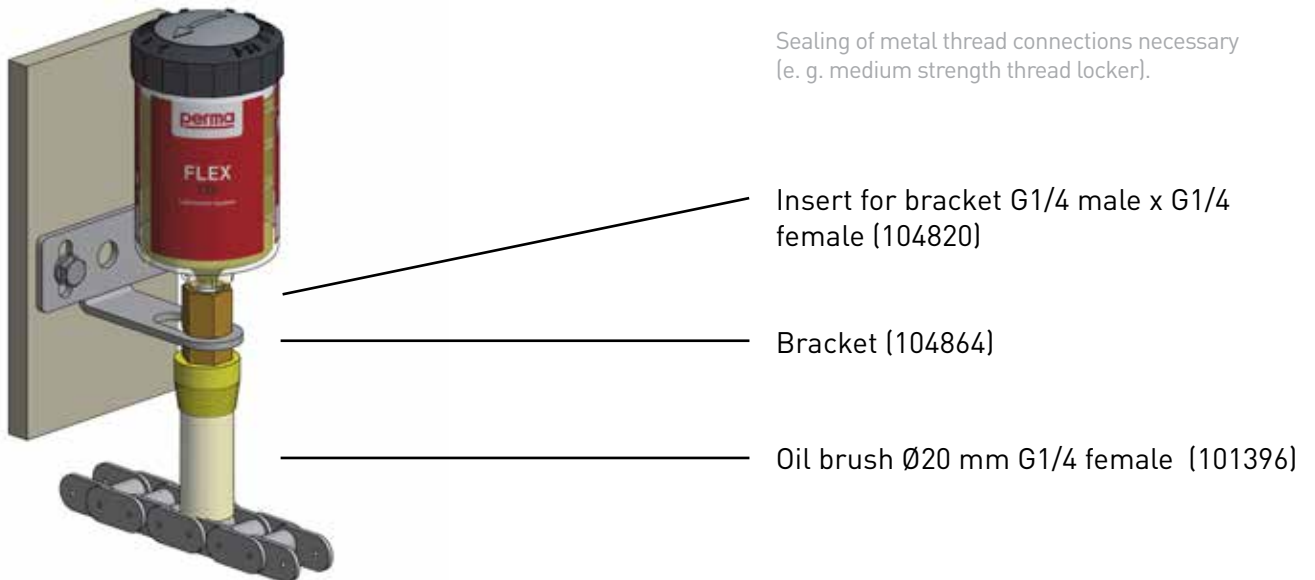

### 2.3.2 Remote mounting

Remote installations of oil filled perma FLEX require an oil retaining valve at the lowest point of the application. This will prevent oil leakage from the lubrication system.

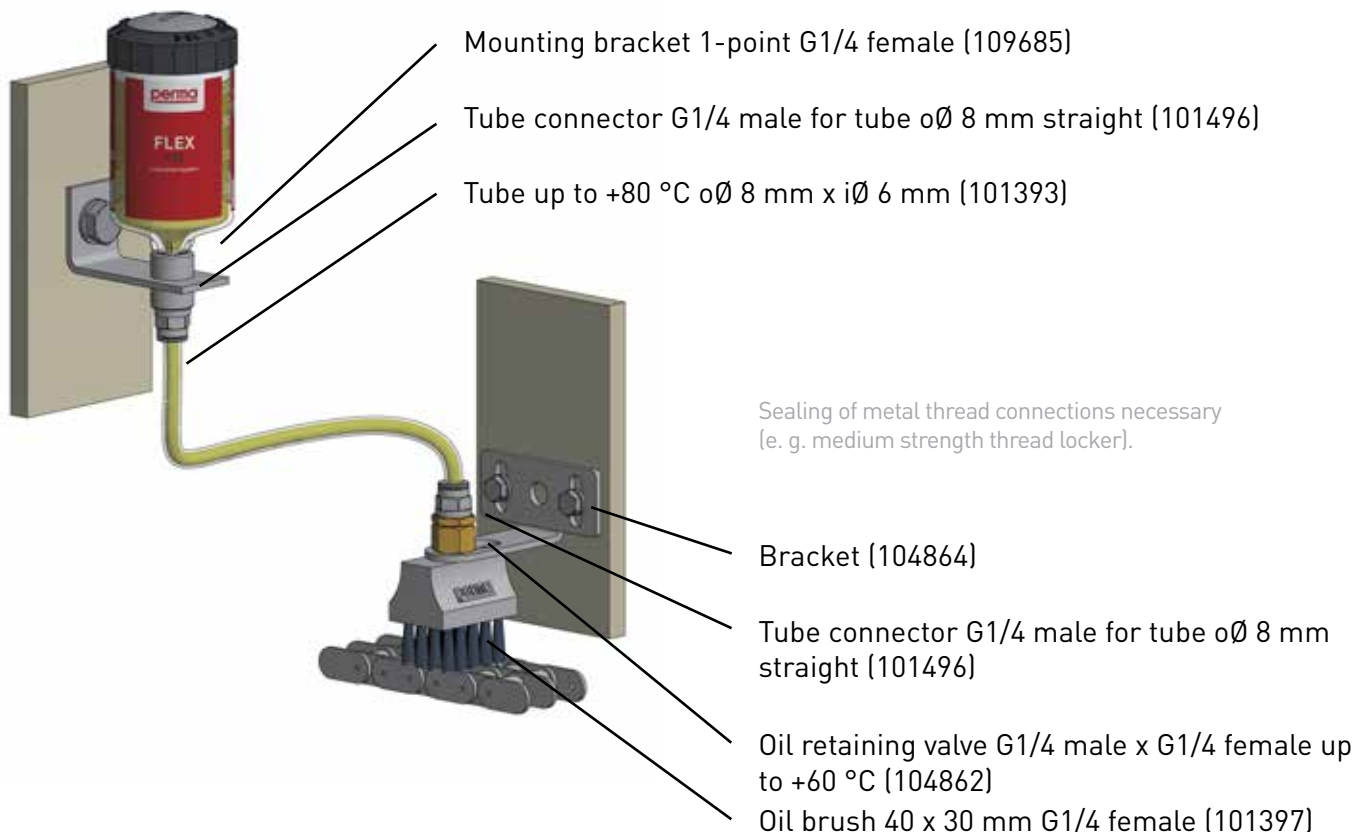

### 3. Preparation of lubrication point

1. Prior to installation, lubrication point must be cleaned to protect against contamination.

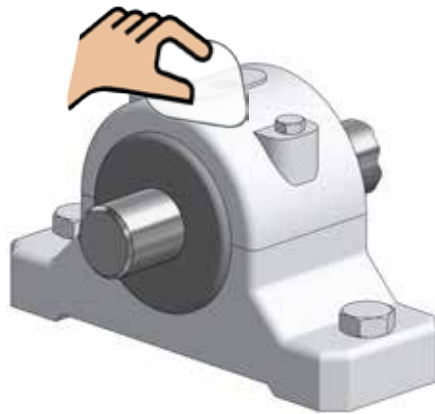

2. Remove grease nipple or plug screw of connecting thread and check thread size.



3. Insert reducer and install tube and necessary accessory parts.



4. Lubrication point, accessory parts and tubes must be pre-filled with lubricant.  
This enables the lubricant to immediately reach the lubrication point.

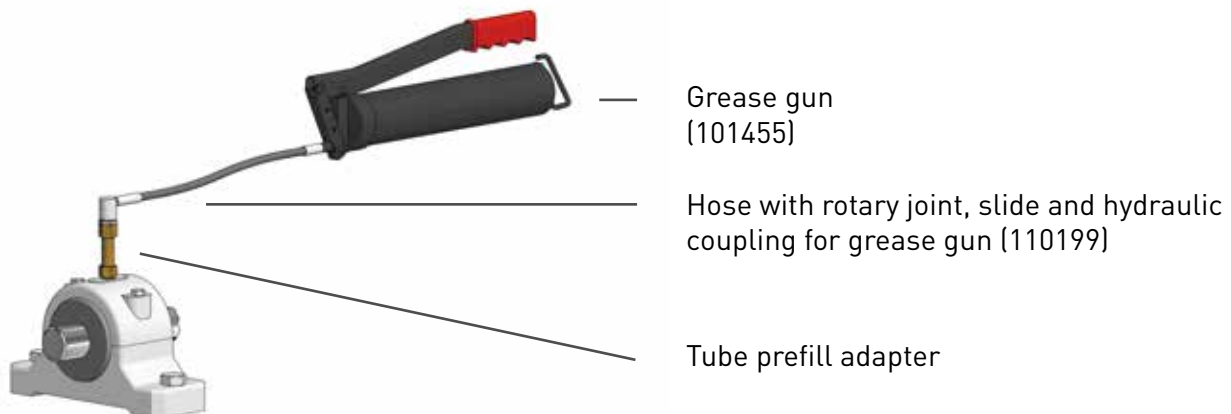

5. Prefill lubrication point and all grease lines for remote installation.



6. Use a tube prefill adapter to prefill lubrication point and grease lines.

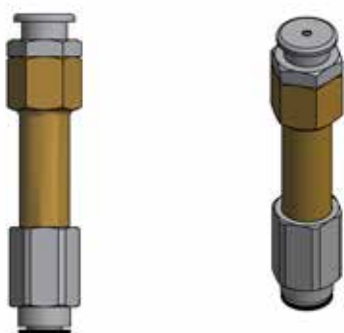

Tube prefill adapter for tube  $\varnothing$  8 mm (101526)

Tube prefill adapter for tube  $\varnothing$  6 mm (101532)

Hose prefill adapter for Heavy Duty hose (107633)

Tube prefill adapter for VA-flex tubes (107634)



## 4. Pressure testing

Check counter pressure at lubrication point before installing the lubrication system to guarantee correct function.

Most bearings require 0.5 - 2 bar pressure (without extension tubes). perma FLEX can be used for these lubrication points.

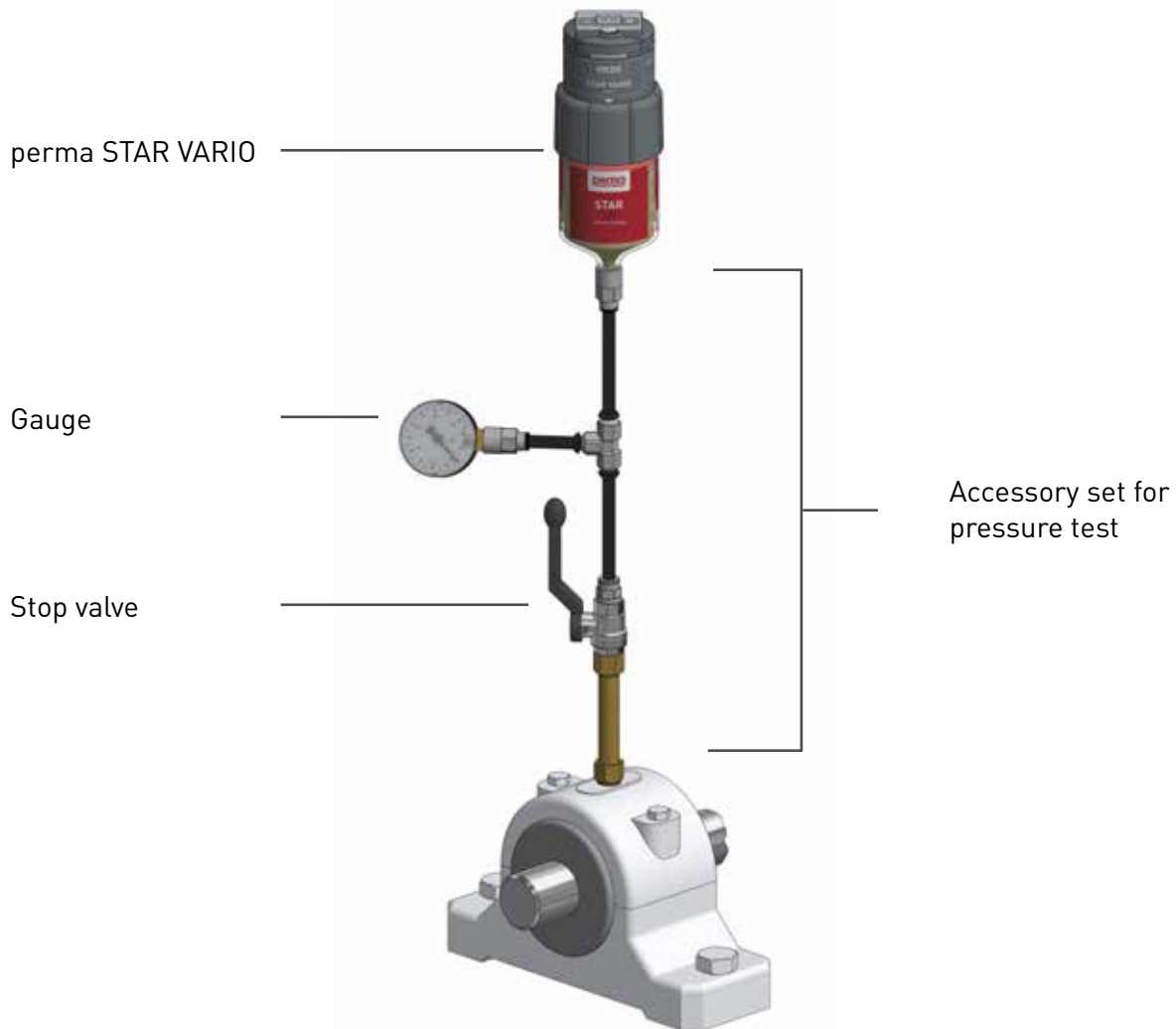

For pressure testing please use perma STAR VARIO with Accessory set for pressure test (101480).

Be sure to use the same lubricant for both, prefilling and LC of perma STAR VARIO.



Accessory set for pressure test (101480)

(order lubrication system separately)

## 4.1 Pressure test procedure

1. Remove grease nipple.
2. Screw reducer onto lube point and connect pressure testing set.
3. Connect perma STAR VARIO to the open outlet.
4. Turn machines on to ensure that lube point is in use and measuring of corresponding counter pressure is possible (Caution: Observe accident prevention regulations).
5. Open stop valve.
6. Push SET button on perma STAR VARIO for approx. 10 seconds until PU lights up on display to trigger an additional discharge/purge.
7. Watch the pressure on the gauge during the additional discharge. If pressure exceeds 6 bar the lubricator will shut off automatically.
8. If pressure doesn't rise any more during the additional discharge, max injection pressure has been reached. In order to find out the required system pressure you must wait another 5 minutes. The gauge will then show the system pressure
9. If system pressure exceeds 2 bar you need to „purge“ the lube point by using a mechanical grease gun. Proceed with steps 6 and 7.
10. If counter pressure doesn't decrease you need to either select a different lubricant or a different lubricator. Please ask perma-tec to assist you in this matter



## 5. Activation und installation

Start up as following (also refer to operating instructions):

1. Use a coin to turn the rotary switch to set the desired discharge period
2. Note activation / exchange date on label
3. Remove plug and screw lubricator into lube point



## 6. Identification of lubrication system

The label of the lubrication system shows product-code, manufacturing date, traceability number, lubricant code and part number.

<p>IP level: 68 II 1 G Ex ia IIC T6 II 1 D Ex iaD 20 T85°C I M1 Ex ia I DEKRA 12ATEX0006 X</p> <p>-20 °C ≤ T<sub>a</sub> ≤ +60 °C Ex ia IIC T6 Ga Ex ia IIIC T85°C Da Ex ia I Ma IECEX DEK 11.0103X</p> <p>IS/I, II, III/1/ABCDEF6/T6(85 °C); -25 °C ≤ T<sub>a</sub> ≤ +65 °C; IP68 V/1/AEx/Exia/IIIC/T6; -25 °C ≤ T<sub>a</sub> ≤ +65 °C; IP68</p> <p>„WARNING - POTENTIAL ELECTROSTATIC CHARGING HAZARD - SEE INSTRUCTIONS“</p> <p>FLEX manufactured by: <b>perma-tec</b> GmbH &amp; Co. KG Hammelburger Str. 21   97717 EUERDORF www.perma-tec.com   Tel.: +49 9704 609-0 Made in Germany</p>	<p>1/1</p> <p>3/4</p>	<p><b>perma</b></p> <p><b>FLEX</b> <b>125</b> Lubrication System</p>	<p>1/1</p> <p>3/4</p>	<p>1 +60 °C 140 °F -20 °C -4 °F</p> <p>2</p> <p>3</p> <p>4</p> <p>5</p>
<p>04/16   10/16</p> <p>125 cm<sup>3</sup> / 4.23 fl.oz. [US]</p>	<p>1/2</p> <p>1/4</p>		<p>1/2</p> <p>1/4</p>	<p>Art. No. 123456   CL-1609-37337 perma Multipurpose grease SF01</p>

Installation date and  
exchange date  
(to be added by operator)

Art. No. | Serial number  
(Product designation – year/week of  
manufacture – internal no.)  
Lubricant designation

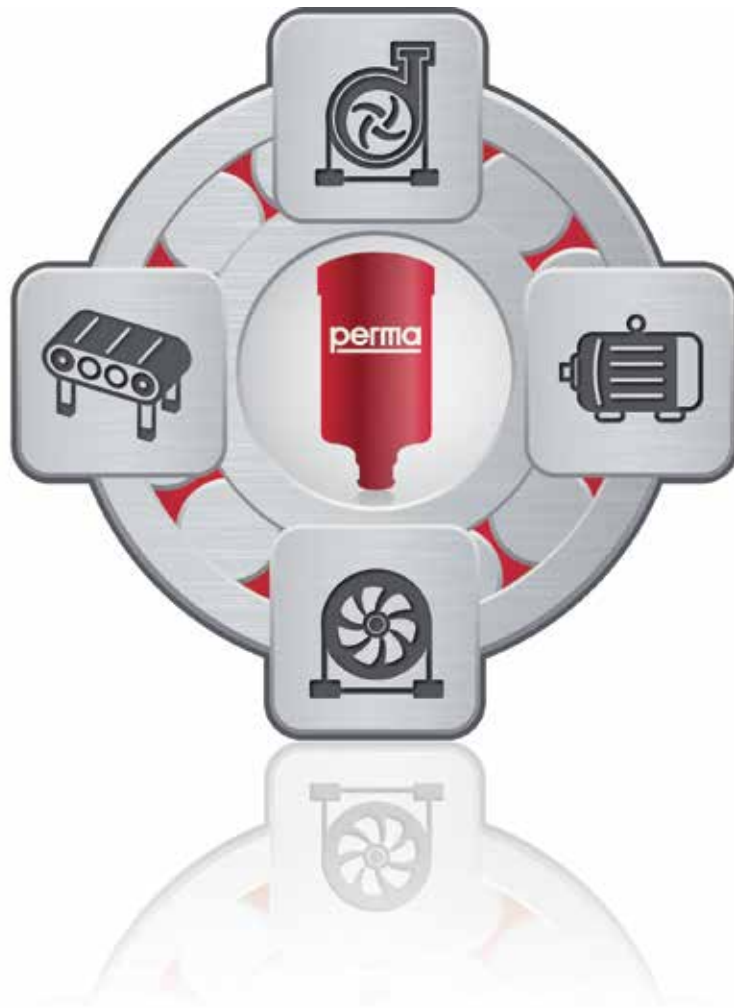

**perma-tec GmbH & Co. KG**  
Hammelburger Str. 21  
97717 EUERDORF  
GERMANY

Tel.: +49 9704 609-0  
[info@perma-tec.com](mailto:info@perma-tec.com)  
[www.perma-tec.com](http://www.perma-tec.com)